

## PRODUCT FEATURES

- Ultrafast Reverse Recovery Time
- Soft Reverse Recovery Characteristics
- Low Reverse Recovery Loss
- Low Forward Voltage
- High Surge Current Capability
- Low Leakage Current



## APPLICATIONS

- Inversion Welder
- Uninterruptible Power Supply
- Plating Power Supply
- Ultrasonic Cleaner and Welder
- Converter & Chopper
- PFC

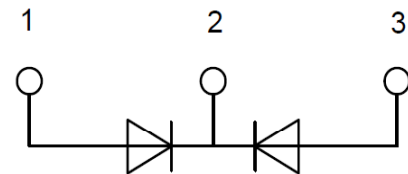

## ABSOLUTE MAXIMUM RATINGS ( $T_C = -25^\circ\text{C}$ unless otherwise specified)

Symbol	Parameter/Test Conditions		Values	Unit
$V_R$	Maximum D.C. Reverse Voltage		600	V
$V_{RRM}$	Maximum Repetitive Reverse Voltage			
$I_{F(AV)}$	Average Forward Current	$T_C = 80^\circ\text{C}$ , Per Diode	150	A
		$T_C = 80^\circ\text{C}$ , Per Module	300	
$I_{F(RMS)}$	RMS Forward Current	$T_C = 80^\circ\text{C}$ , Per Diode	212	
$I_{FSM}$	Non Repetitive Surge Forward Current	$T_J = 45^\circ\text{C}$ , $t = 10\text{ms}$ , Sine, peak value	1410	
		$T_J = 45^\circ\text{C}$ , $t = 8.3\text{ms}$ , Sine, peak value	1550	
$I^2t$	For Fusing	$T_J = 45^\circ\text{C}$ , $t = 10\text{ms}$ , Sine, peak value	9941	$\text{A}^2\text{S}$
		$T_J = 45^\circ\text{C}$ , $t = 8.3\text{ms}$ , Sine, peak value	9970	
$P_D$	Power Dissipation		370	W
$T_J$	Junction Temperature		-40 to +150	$^\circ\text{C}$
$T_{STG}$	Storage Temperature Range		-40 to +125	$^\circ\text{C}$
$V_{isol}$	Isolation Breakdown Voltage	AC, 50Hz(R.M.S), $t = 1\text{minute}$	3000	V
Torque	Module to Sink	Recommended (M5)	2.5~4	Nm
Torque	Module Electrodes	Recommended (M5)	2.5~4	Nm
$R_{thJC}$	Junction to Case Thermal Resistance(Per Diode)		0.34	$^\circ\text{C}/\text{W}$
Weight			100	g

MacMic Science & Technology Co., Ltd.

Add: #18, Hua Shan Zhong Lu, New District, Changzhou City, Jiangsu Province, P. R. of China

# MMF300N060DK6B

## ELECTRICAL CHARACTERISTICS ( $T_C=25^\circ\text{C}$ unless otherwise specified)

Symbol	Parameter/Test Conditions	Min.	Typ.	Max.	Unit
$I_{RM}$	Maximum Reverse Leakage Current	$V_R = 600\text{V}$		1	mA
		$V_R = 600\text{V}, T_J = 125^\circ\text{C}$		10	
$V_F$	Forward Voltage	$I_F = 150\text{A}$	1.25	1.7	V
		$I_F = 150\text{A}, T_J = 125^\circ\text{C}$		1.1	
$t_{rr}$	Reverse Recovery Time ( $I_F = 1\text{A}, di_F/dt = -200\text{A}/\mu\text{s}, V_R = 30\text{V}$ )		45		ns
$t_{rr}$	Reverse Recovery Time		95		ns
$I_{RRM}$	Maximum Reverse Recovery Current		9		A
$t_{rr}$	Reverse Recovery Time		190		ns
$I_{RRM}$	Maximum Reverse Recovery Current		19		A

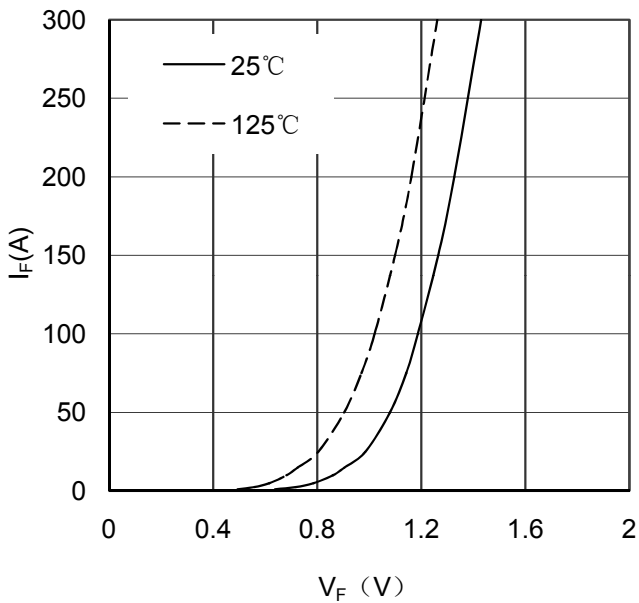

Figure 1. Forward Voltage Drop vs Forward Current

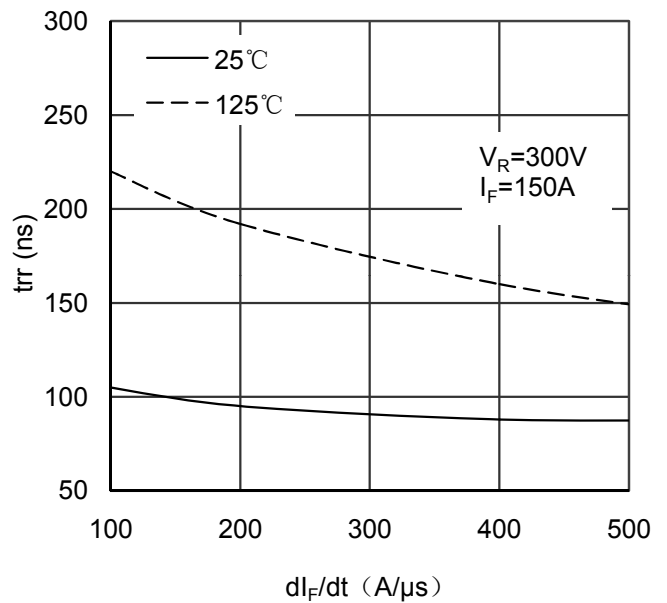

Figure 2. Reverse Recovery Time vs  $di_F/dt$

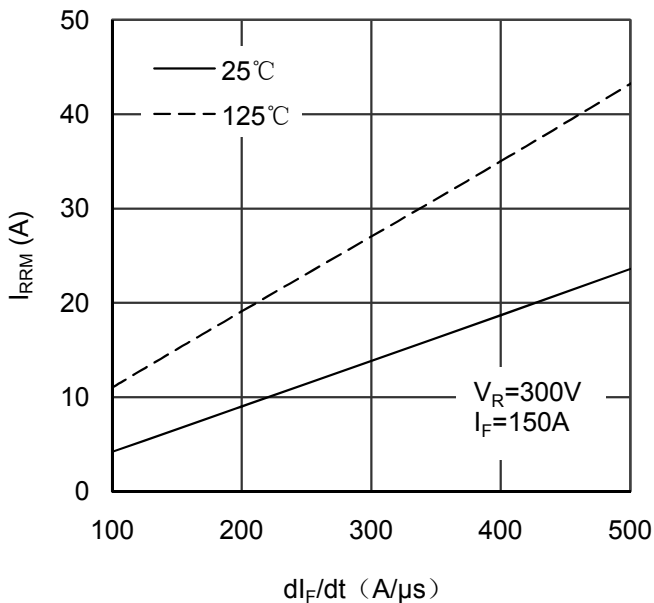

Figure 3. Reverse Recovery Current vs  $di_F/dt$

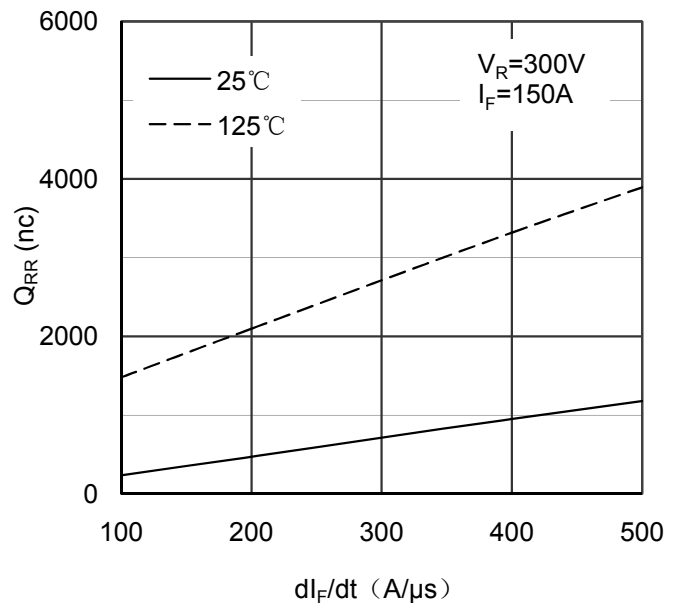

Figure 4. Reverse Recovery Charge vs  $di_F/dt$

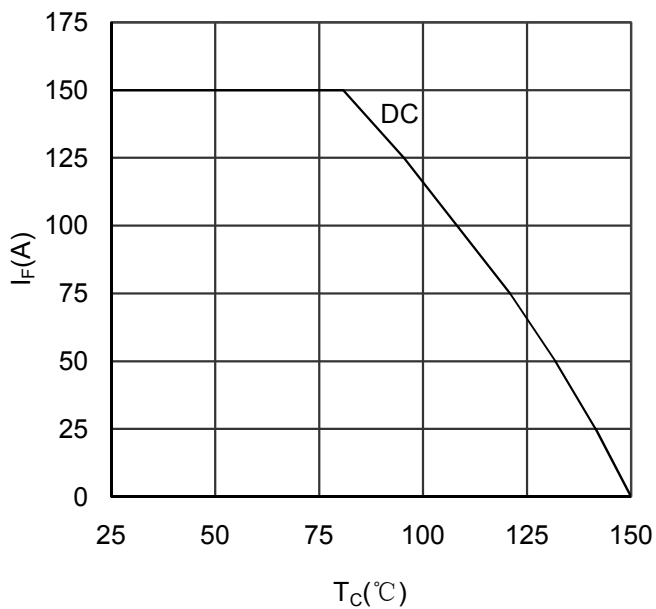

Figure 5. Forward current vs Case temperature

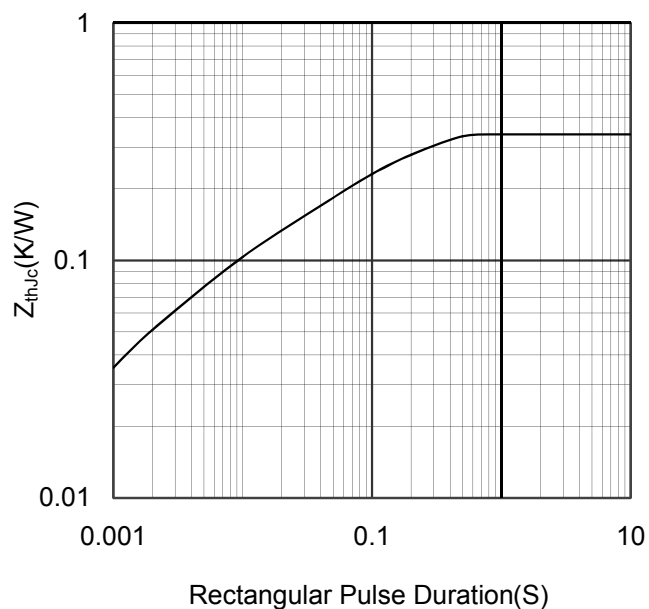
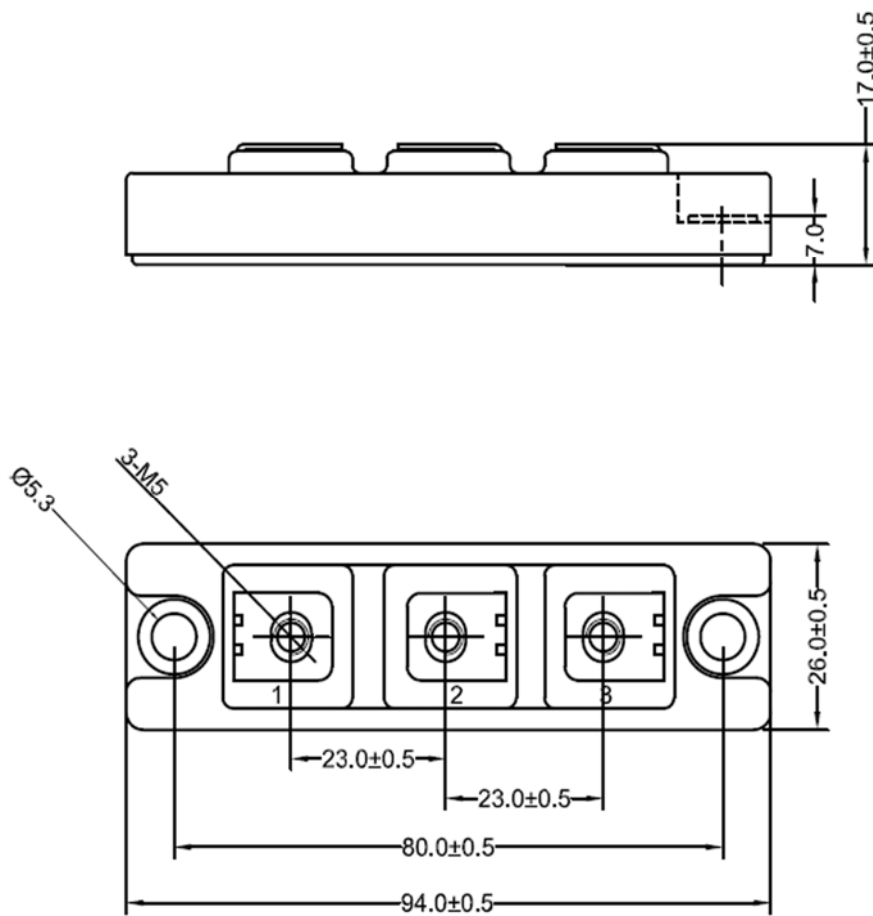

Figure 6. Transient Thermal Impedance



Dimensions in (mm)  
Figure 7. Package Outline