

PRODUCT FEATURES

- 750V Field Stop Trench IGBT
- $V_{CE(sat)}$ with positive temperature coefficient
- Fast switching and short tail current
- Free wheeling diodes with fast and soft reverse recovery
- Max Junction Temperature 175°C
- Temperature sense included

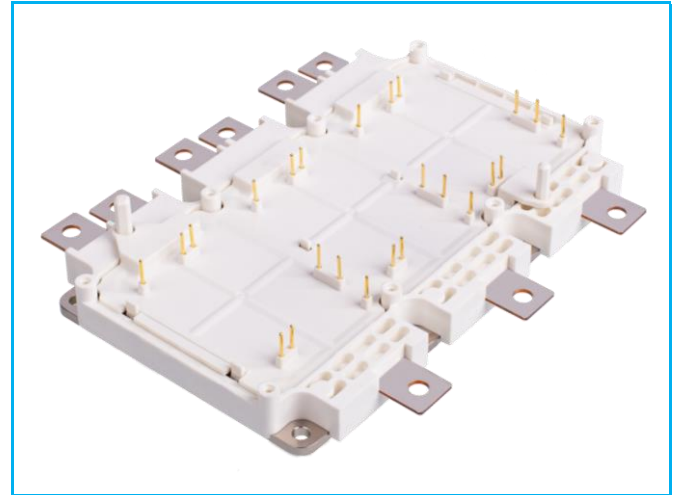

APPLICATIONS

- Automotive Traction Modules
- General Power Modules

IGBT-inverter

ABSOLUTE MAXIMUM RATINGS ($T_F=25^\circ\text{C}$ unless otherwise specified)

Symbol	Parameter/Test Conditions		Values	Unit
V_{CES}	Collector Emitter Voltage	$T_J=25^\circ\text{C}$	750	V
V_{GES}	Gate Emitter Voltage		± 20	
I_{CN}	Implemented Collector Current		820	A
I_C	DC Collector Current	$T_F=80^\circ\text{C}, T_{Jmax}=175^\circ\text{C}$	450	
I_{CM}	Repetitive Peak Collector Current	$tp=1\text{ms}$	1640	
P_{tot}	Power Dissipation Per IGBT	$T_F=25^\circ\text{C}, T_{Jmax}=175^\circ\text{C}$	1154	W

Diode-inverter

ABSOLUTE MAXIMUM RATINGS ($T_F=25^\circ\text{C}$ unless otherwise specified)

Symbol	Parameter/Test Conditions		Values	Unit
V_{RRM}	Repetitive Reverse Voltage	$T_J=25^\circ\text{C}$	750	V
I_{FN}	Implemented Forward Current		820	A
$I_{F(AV)}$	Average Forward Current		450	
I_{FRM}	Repetitive Peak Forward Current	$tp=1\text{ms}$	1640	
I^2t		$T_J=150^\circ\text{C}, t=10\text{ms}, V_R=0\text{V}$	31.25	kA^2s

MacMic Science & Technology Co., Ltd.

Add: #18, Hua Shan Zhong Lu, New District, Changzhou City, Jiangsu Province, P. R. of China

Tel.: +86-519-85163708 Fax: +86-519-85162291 Post Code: 213022 Website: www.macmicst.com

MMG820V075X6RS

IGBT-inverter

ELECTRICAL CHARACTERISTICS ($T_F=25^\circ\text{C}$ unless otherwise specified)

Symbol	Parameter/Test Conditions		Min.	Typ.	Max.	Unit
$V_{GE(th)}$	Gate Emitter Threshold Voltage	$V_{CE}=V_{GE}, I_C=9.6\text{mA}$	4.6	5.4	6.2	V
$V_{CE(sat)}$	Collector Emitter Saturation Voltage	$I_C=450\text{A}, V_{GE}=15\text{V}, T_J=25^\circ\text{C}$		1.15	1.38	
		$I_C=450\text{A}, V_{GE}=15\text{V}, T_J=150^\circ\text{C}$		1.25		
		$I_C=450\text{A}, V_{GE}=15\text{V}, T_J=175^\circ\text{C}$		1.25		
		$I_C=820\text{A}, V_{GE}=15\text{V}, T_J=25^\circ\text{C}$		1.35		
		$I_C=820\text{A}, V_{GE}=15\text{V}, T_J=175^\circ\text{C}$		1.6		
I_{CES}	Collector Leakage Current	$V_{CE}=750\text{V}, V_{GE}=0\text{V}, T_J=25^\circ\text{C}$			1	mA
		$V_{CE}=750\text{V}, V_{GE}=0\text{V}, T_J=150^\circ\text{C}$			5	mA
I_{GES}	Gate Leakage Current	$V_{CE}=0\text{V}, V_{GE}=\pm 20\text{V}, T_J=25^\circ\text{C}$	-400		400	nA
R_{Gint}	Integrated Gate Resistor			1.4		Ω
Q_G	Gate Charge	$V_{CE}=400\text{V}, I_C=450\text{A}, V_{GE}=15\text{V}$		1.2		μC
C_{ies}	Input Capacitance	$V_{CE}=25\text{V}, V_{GE}=0\text{V}, f=1\text{MHz}$		33.5		nF
C_{res}	Reverse Transfer Capacitance				0.63	
$t_{d(on)}$	Turn on Delay Time	$V_{CC}=400\text{V}, I_C=450\text{A}$ $R_G=2.7\Omega,$ $V_{GE}=\pm 15\text{V},$ Inductive Load	$T_J=25^\circ\text{C}$	98		ns
			$T_J=150^\circ\text{C}$	104		ns
t_r	Rise Time		$T_J=25^\circ\text{C}$	58		ns
			$T_J=150^\circ\text{C}$	62		ns
$t_{d(off)}$	Turn off Delay Time	$V_{CC}=400\text{V}, I_C=450\text{A}$ $R_G=2.7\Omega,$ $V_{GE}=\pm 15\text{V},$ Inductive Load	$T_J=25^\circ\text{C}$	480		ns
			$T_J=150^\circ\text{C}$	540		ns
t_f	Fall Time		$T_J=25^\circ\text{C}$	70		ns
			$T_J=150^\circ\text{C}$	130		ns
E_{on}	Turn on Energy	$V_{CC}=400\text{V}, I_C=450\text{A}$ $R_G=2.7\Omega,$ $V_{GE}=\pm 15\text{V},$ Inductive Load	$T_J=25^\circ\text{C}$	16.8		mJ
			$T_J=150^\circ\text{C}$	21.1		mJ
E_{off}	Turn off Energy		$T_J=25^\circ\text{C}$	15.7		mJ
			$T_J=150^\circ\text{C}$	25		mJ
I_{SC}	Short Circuit Current	$tpsc \leq 3\mu\text{s}, V_{GE}=15\text{V}$ $T_J=150^\circ\text{C}, V_{CC}=400\text{V}$		4500		A
R_{thJF}	Junction to cooling fluid, $\Delta V/\Delta t = 10 \text{ dm}^3/\text{min}, T_F = 25^\circ\text{C}$ (Per IGBT)				0.13	K /W

Diode-inverter

ELECTRICAL CHARACTERISTICS ($T_F=25^\circ\text{C}$ unless otherwise specified)

Symbol	Parameter/Test Conditions		Min.	Typ.	Max.	Unit
V_F	Forward Voltage	$I_F=450\text{A}, V_{GE}=0\text{V}, T_J=25^\circ\text{C}$		1.27	1.53	V
		$I_F=450\text{A}, V_{GE}=0\text{V}, T_J=150^\circ\text{C}$		1.29		
		$I_F=450\text{A}, V_{GE}=0\text{V}, T_J=175^\circ\text{C}$		1.29		
		$I_F=820\text{A}, V_{GE}=0\text{V}, T_J=25^\circ\text{C}$		1.50		
		$I_F=820\text{A}, V_{GE}=0\text{V}, T_J=175^\circ\text{C}$		1.64		
t_{rr}	Reverse Recovery Time	$I_F=450\text{A}, V_R=400\text{V}$ $dI_F/dt=-6900\text{A}/\mu\text{s}$ $T_J=150^\circ\text{C}$		230		ns
I_{RRM}	Max. Reverse Recovery Current			460		A
Q_{RR}	Reverse Recovery Charge			63.4		μC
E_{rec}	Reverse Recovery Energy			20.6		mJ
R_{thJF}	Junction to cooling fluid, $\Delta V/\Delta t = 10 \text{ dm}^3/\text{min}, T_F = 25^\circ\text{C}$ (Per Diode)				0.19	K /W

MMG820V075X6RS

NTC CHARACTERISTICS ($T_F=25^\circ\text{C}$ unless otherwise specified)

Symbol	Parameter/Test Conditions	Min.	Typ.	Max.	Unit
R_{25}	Resistance $T_F=25^\circ\text{C}$		5		k Ω
$B_{25/50}$	$R_2 = R_{25} \exp [B_{25/50}(1/T_2 - 1/(298.15 \text{ K}))]$		3375		K

MODULE CHARACTERISTICS ($T_F=25^\circ\text{C}$ unless otherwise specified)

Symbol	Parameter/Test Conditions	Values	Unit	
T_{Jmax}	Max. Junction Temperature	175	°C	
T_{Jop}	Operating Temperature	-40~150		
T_{stg}	Storage Temperature	-40~125		
V_{isol}	Isolation Breakdown Voltage	RMS, $f = 0 \text{ Hz}$, $t = 1 \text{ sec}$	4200	V
CTI	Comparative Tracking Index		> 200	
Torque	baseplate to heatsink	Recommended (M4)	1.8~2.2	Nm
	PCB to frame	Recommended (M3)	0.65~0.75	Nm
Weight			775	g

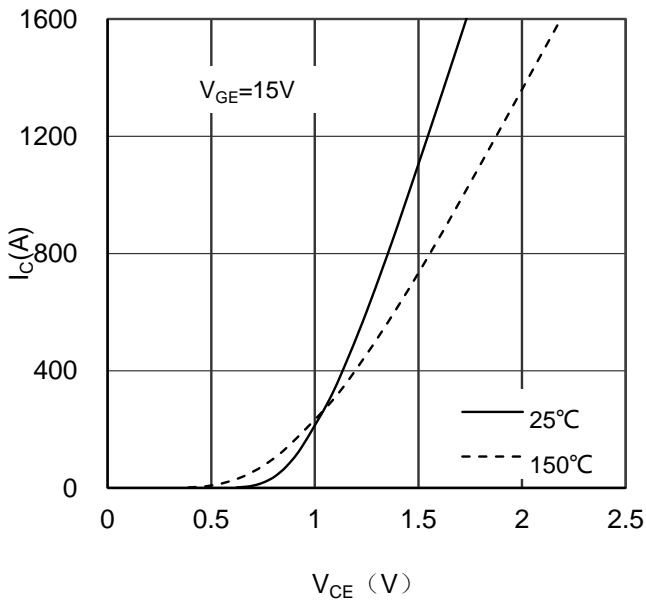

Figure 1. Typical Output Characteristics IGBT-inverter

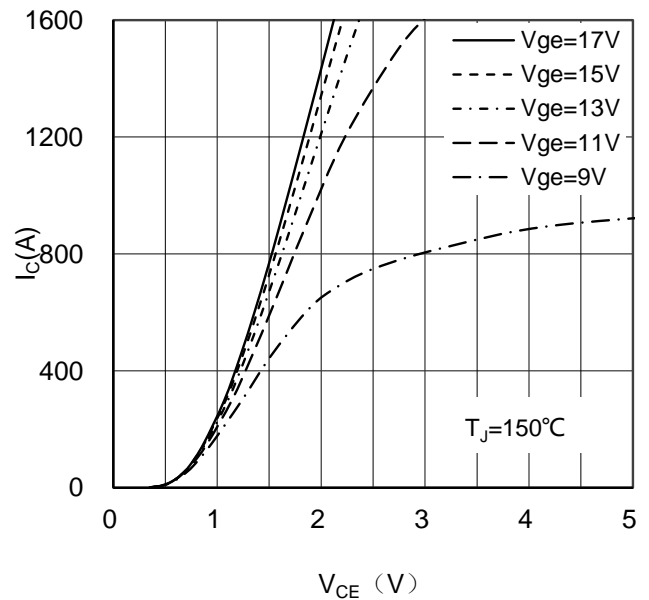

Figure 2. Typical Output Characteristics IGBT-inverter

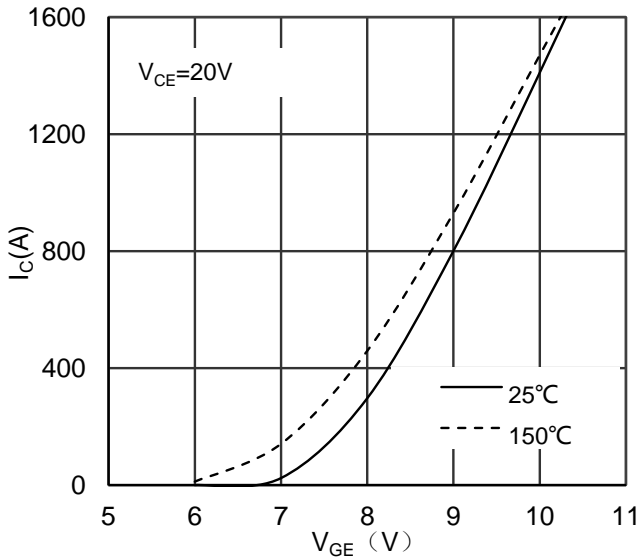

Figure 3. Typical Transfer characteristics IGBT-inverter

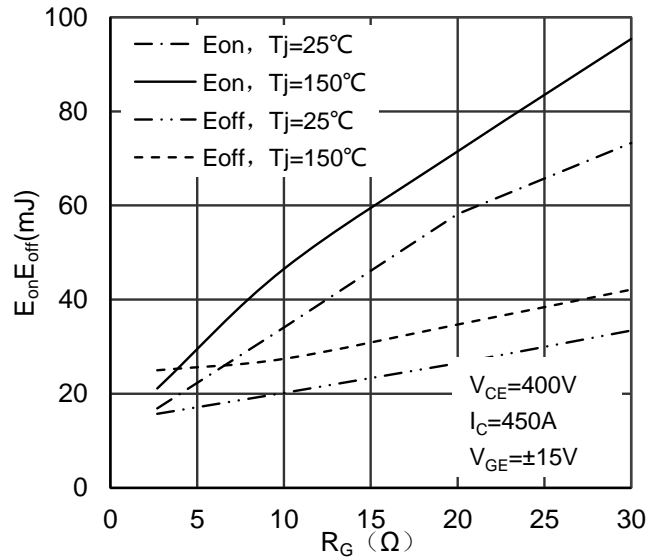

Figure 4. Switching Energy vs Gate Resistor IGBT-inverter

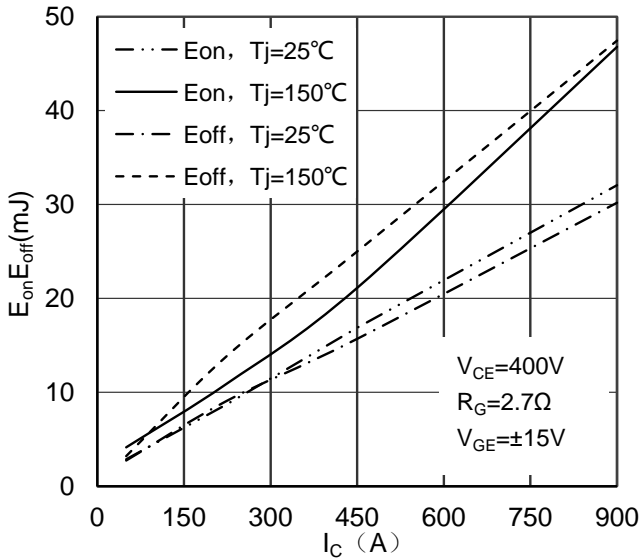

Figure 5. Switching Energy vs Collector Current IGBT-inverter

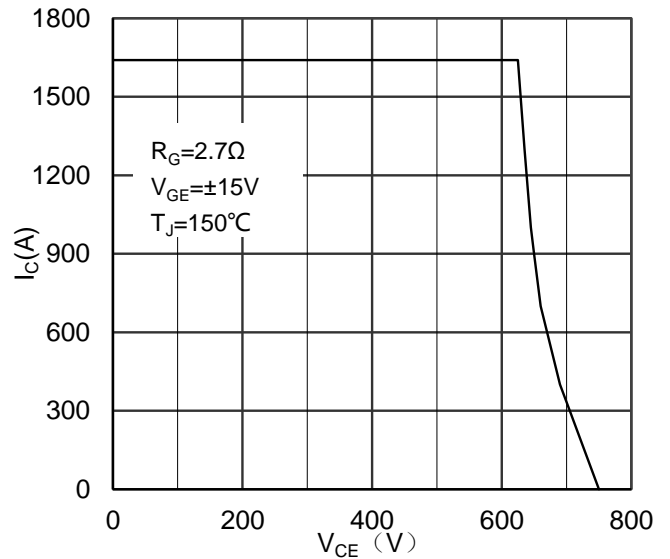

Figure 6. Reverse Biased Safe Operating Area IGBT-inverter

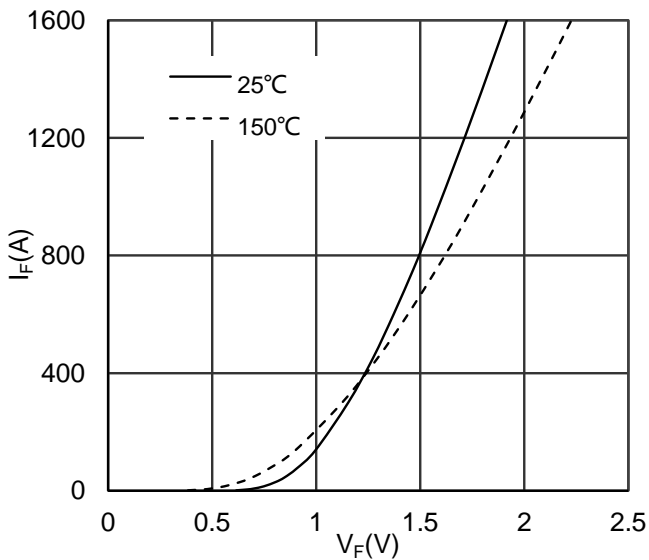

Figure 7. Diode Forward Characteristics Diode-inverter

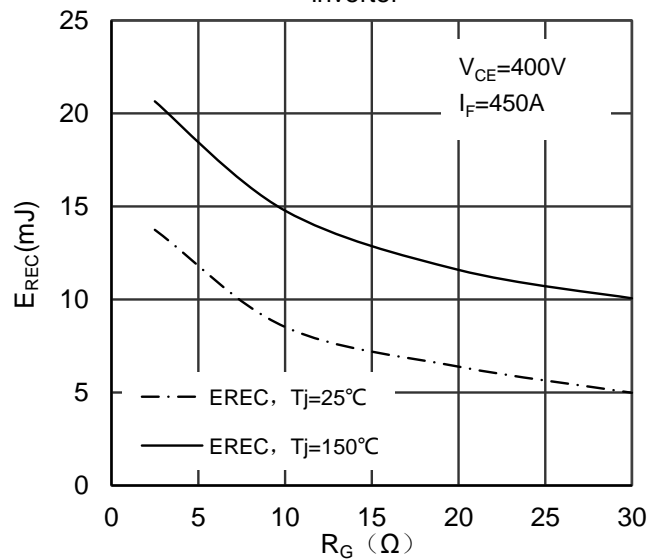

Figure 8. Switching Energy vs Gate Resistor Diode-inverter

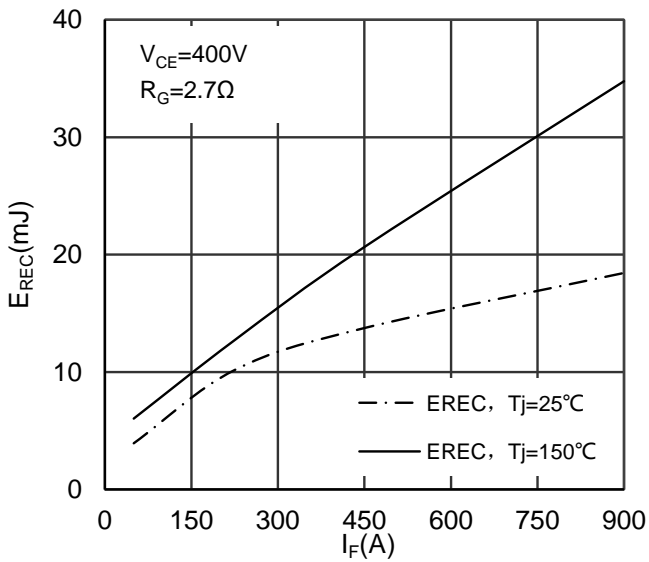

Figure 9. Switching Energy vs Forward Current Diode-inverter

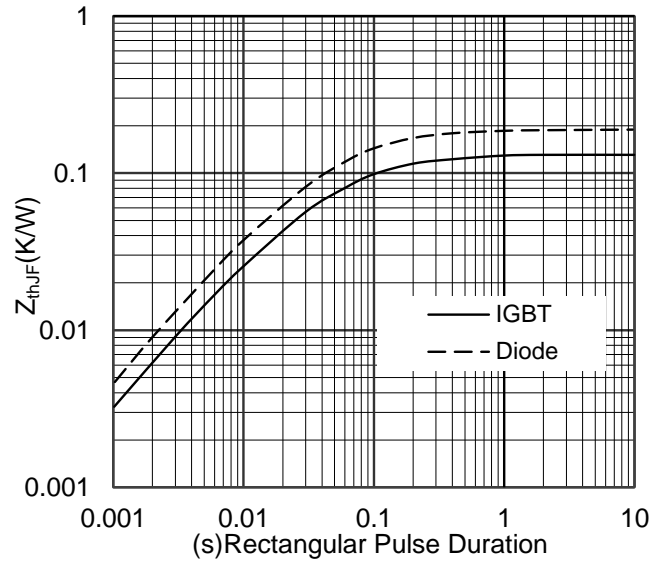

Figure 10. Transient Thermal Impedance of Diode and IGBT-inverter

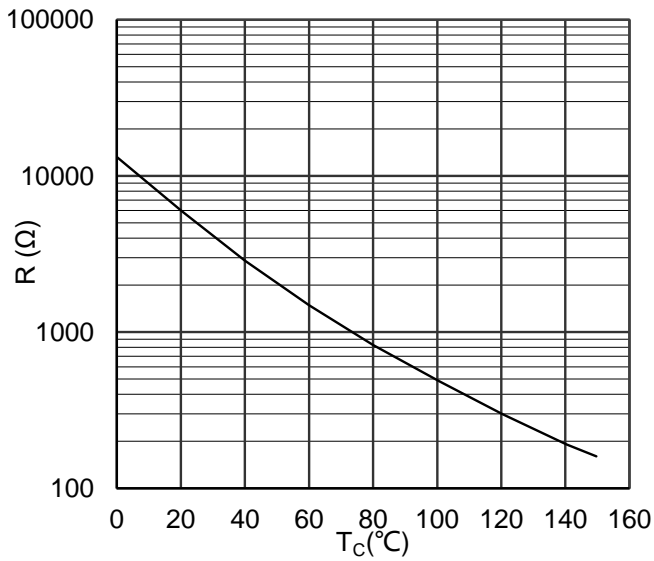

Figure 11. NTC Characteristics

MMG820V075X6RS

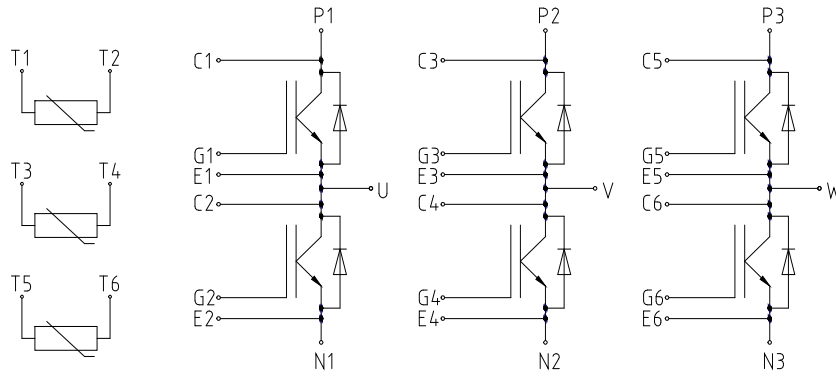

Figure 12. Circuit Diagram

