

Comparison of PIM modules with separate inverter and rectifier schemes in inverter applications

Tao Zhang¹, Guokang Chen¹, Rui Rong¹, Shuai Cao¹, Shuo Miao¹.

¹Macmic science & technology Co.,Ltd.,China

Corresponding author: Tao Zhang, tzhang@macmicst.com

Speaker: Tao Zhang

Abstract

As we all know, in many industrial fields, such as frequency inverters, servo motors need to use rectifiers and inverters. Their circuit topology diagram is the rectifier bridge plus three-phase inverter circuit. Here we take the frequency converter as an example. Generally speaking, the motor power range of the low-power inverter is 0.4-3KW, the motor power range of the medium-power inverter is 3-30KW, and the motor power range of the high-power inverter is 30-200KW. In the low power segment of the inverter, there are single tube and module schemes to choose, this paper is mainly introduced in the module scheme integrated PIM module and rectifier bridge and inverter separate two different scheme choices.

1 Introduction

The main circuit topology of the inverter is shown in Fig. 1.

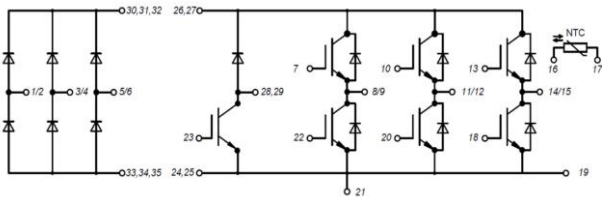

Fig. 1. Frequency converter application topology

It is composed of the rectifier bridge + brake unit + inverter.

In the small power segment frequency converter, we usually use a single tube scheme at the beginning, in the same power segment of the frequency converter, the advantage of the single tube scheme is small size, the whole machine structure is more flexible, and the cost of solving the process problem is lower than the module. The advantages of modular scheme are simple manufacturing process and high reliability. In the module scheme, there is a PIM module with a relatively high degree of integration, and there is also a scheme that the inverter and the rectifier are separated.

2 Comparison

2.1 Package size comparison

Take the IGBT module 75A 1200V as an example. Before we developed the latest generation of 7th technology, customers usually chose the following solution, Fig. 2



Fig. 2. GW package shape

is the PIM module, which we call GW, the module integrates the three-phase full bridge circuit, the rectifier bridge circuit and the brake unit. After the 7th chip is used, the package size is greatly reduced, and we call this package GH, as shown in Fig. 3.



Fig. 3. GH package shape

By reducing the package size of the IGBT, the customer's machine volume can be reduced by at least 30%-40%. This greatly reduces the cost of the customer's complete machine. Which makes customers more competitive and advantageous in the market.

New technologies also bring new applications. In the 18.5kW power range, different packaging solutions are

available. We enclose the inverter unit in the GCE package, as shown in Fig. 4,

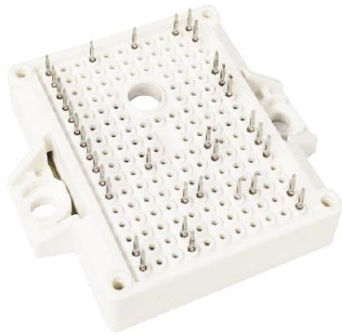

Fig. 4. GCE package shape

and the rectifier bridge and brake unit in the GCB, as shown in Fig. 5.

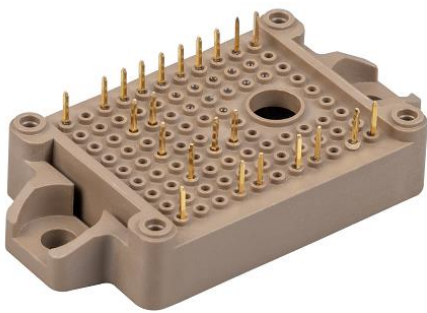

Fig. 5. GCB package shape

This is the main content of this article. Products using the seventh generation chip have reduced the size of the original PIM package. The power of the inverter can be further improved. At the same time, the PIM module can be replaced with two smaller packages.

2.2 Cost comparison

The overall cost of GH package is similar to the cost of GCE plus GCB, mainly due to the difference in DBC size and the difference in the base plate.

The overall cost of GH package is similar to the cost of GCE plus GCB, mainly due to the difference in DBC size and the difference in the base plate. A copper plate like the GH package costs about \$2 more than two modules without a copper base. The following three diagrams show the difference between a copper base and a bare DBC base.



Fig. 6. IGBT module with copper base plate

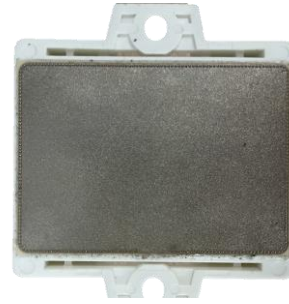

Fig. 7. Non-copper baseplate module



Fig. 8. Non-copper baseplate module

2.3 Feature comparison

In the 18.5Kw power range, there is little difference in heating between the two schemes using the same chip. But in small packages, the rectifier diode chip size limits its surge current. On the contrary, the rectifier chip can be packaged separately to avoid the failure caused by insufficient surge resistance. Table. 1. below shows the test results.

I _{FSM} /A	10ms single	25°C	PIM		sixpack+rectifier	
			1#	2#	1#	2#
			770 OK	771 OK	1010 OK	1023 OK
			856 FAIL	857 FAIL	1134 FAIL	1139 FAIL

Table. 1. Results of IFSM comparison

From the test data, we can see that the chip size of the rectifier chip is limited due to the limitations of the package of the PIM module. This also results in inrush currents that are not sufficient to compare with comparable current specifications in larger packages. Therefore, we sometimes choose to separate the inverter and rectifier parts of the scheme.

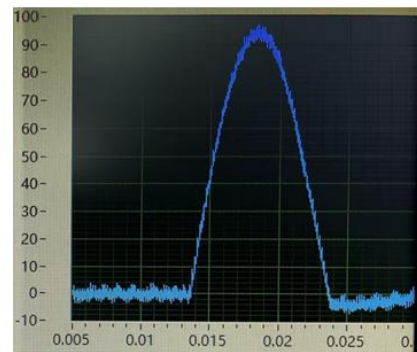

Fig. 9. Inrush current test diagram

If the power is increased by a level, although the chip size can still be placed in a small package, the high heat brought by a small chip can not be solved well in this package. Here I will verify my conjecture through simulation.

3 Simulation Result

We have made corresponding thermal simulations for different packages, as shown in the **Fig. 10** below.

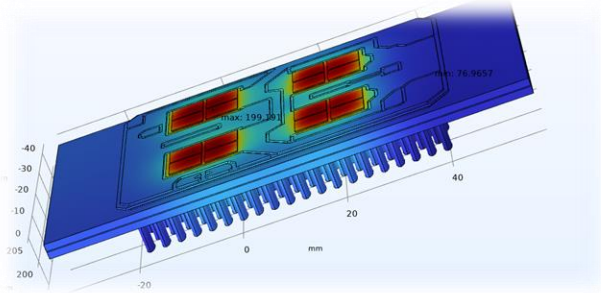

Fig. 10. Thermal simulation

First of all, we calculate the approximate module loss according to the actual application conditions of customers. The loss of the module is mainly obtained by adding the loss of the IGBT and the loss of the diode. The loss is divided into on-off loss and on-off loss. The following are some formulas for loss calculation.

3.1 Conduction Losses

IGBT Conduction losses can be calculated using an IGBT approximation with a series connection of DC voltage source (U_{CE0}) representing IGBT on-state zero-current collector-emitter voltage and a collector-emitter on-state resistance (r_C):

$$U_{CE}(i_C) = U_{CE0} + r_C \cdot i_C$$

The same approximation can be used for the anti-parallel diode, giving:

$$U_D(i_D) = U_{D0} + r_D \cdot i_D$$

If the average IGBT current value is I_{cav} , and the rms value of IGBT current is I_{crms} , then the average losses can be expressed as:

$$P_{CT} = \frac{1}{T_{SW}} \int_0^{T_{SW}} P_T(t) dt = \frac{1}{T_{SW}} \int_0^{T_{SW}} (U_{CE0} \cdot i_C(t) + r_C \cdot i_C^2(t) dt)$$

If the average diode current is I_{Dav} , and the rms diode current is I_{Drms} , the average diode conduction losses across the switching period ($T_{sw}=1/f_{sw}$) are:

$$P_{CD} = \frac{1}{T_{SW}} \int_0^{T_{SW}} P_{CD}(t) dt = \frac{1}{T_{SW}} \int_0^{T_{SW}} (U_{D0} \cdot i_D(t) + r_D \cdot i_D^2(t) dt)$$

3.2 Switching Losses

The circuit for the examination of the IGBT switching losses is presented in **fig. 11**. It is a single-quadrant chopper supplying an inductive type load. The IGBT is

driven from the driver circuit, providing a voltage U_{Dr} at its output. The IGBT internal diode is used as a free-wheeling diode, because in the majority of applications, such as 3-phase AC motor drives, bi-directional DC-motor drives, full-bridge DC/DC converters, etc., the power electronics converter consists of one or more IGBT-based half-bridges. If an external free-wheeling diode is used, the calculations are still valid, provided the diode parameters are taken from the diode data-sheet.

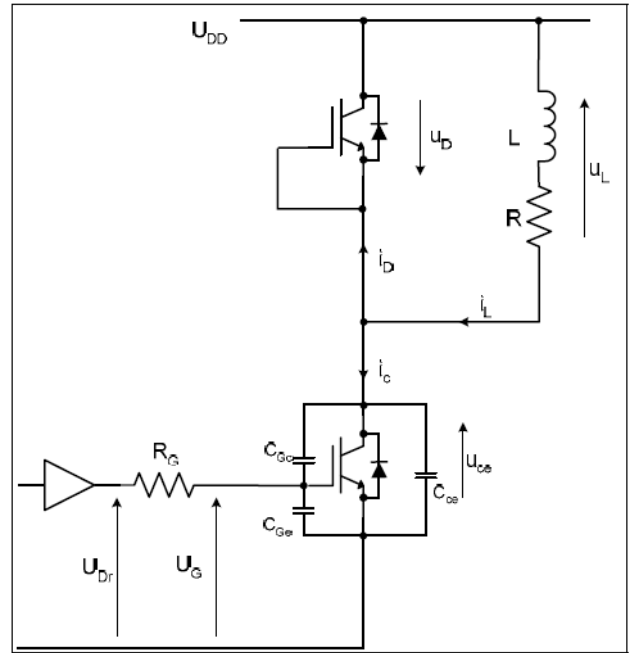

Fig. 11. IGBT chopper driving an inductive load

The turn-on energy losses in IGBT (E_{onT}) can be calculated as the sum of the switch-on energy without taking the reverse recovery process into account (E_{onTi}) and the switch-on energy caused by the reverse-recovery of the free-wheeling diode (E_{onTrr}):

$$E_{onT} = \int_0^{tri+tfu} U_{ce}(t) \cdot i_c(t) dt = E_{onMi} + E_{onMrr}$$

Turn-on energy in the diode consists mostly of the reverse-recovery energy (E_{onD}):

$$E_{onD} = \int_0^{tri+tfu} U_D(t) \cdot i_F(t) dt \approx \frac{1}{4} \cdot Q_{rr} \cdot U_{Dr}$$

3.3 Loss calculation

The application conditions are as follows:

DC bus voltage	540	V
Output current	60	A
Switching frequency	6	kHz
Power factor	0.85	
Modulation ratio	1	
Rg-on	6.8	Ω
Rg-off	6.8	Ω
Radiator temperature	90	$^{\circ}\text{C}$
Environment temperature	60	$^{\circ}\text{C}$

Table 2. Enter application conditions

The loss is calculated as follows:

Simulation result					
		PIM		sixpack+rectifier	
IGBT	P_cond	31.05	w	31.32	w
	Psw	43.34	w	50.01	w
DIODE	P_cond	6.53	w	6.52	w
	Psw_rr	7.20	w	4.15	w
Ptot		74.39	w	81.33	w

Table 3. Simulation result

From the simulation results, it can be seen that the module loss with copper base plate will be lower.

4 Experimental result

According to the calculated loss results, the thermal model is simulated.

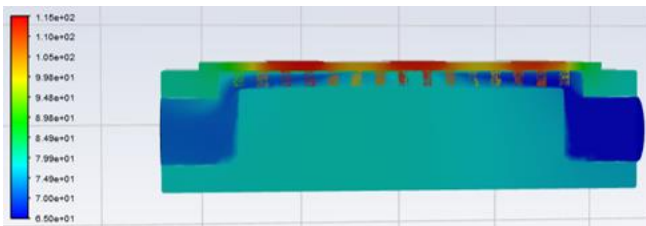

Fig. 12. Thermal simulation with copper base plate

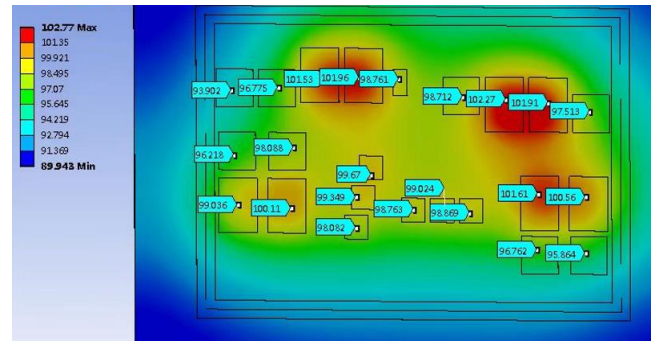

Fig. 13. Thermal simulation without copper base plate
According to the simulation results, in the high-current module module, the heat dissipation of the module with copper base plate is better than that of the module without copper base plate. If it is a low-power machine, in order to meet the requirements of the surge current, we recommend that the rectifier and the inverter be separated.

5 Conclusion

Based on the 7th generation IGBT chip technology, the overall package size has been reduced a lot. As a result, a lot of power segments have been improved without changing the original package size. However, the capability of the rectifier chip is not enough to support the upgrade of the product. The lack of resistance of rectifier chip to inrush current has become the bottleneck in some application fields. Therefore, the rectifier bridge will be packaged separately, and the limitation of the package size to the rectifier chip will be laughed at. To sum up, both schemes are feasible. The option you choose often depends on the impact during actual use. The scheme is fixed, but the people who use it are flexible. The first element we choose in the scheme is to facilitate our practical application.

6 References

- [1] A Learning-Based Thermal Simulation Framework for Emerging Two-Phase Cooling Technologies, 2020 Design, Automation & Test in Europe Conference & Exhibition
- [2] Recent Advances and Trends in Advanced Packaging, IEEE Transactions on Components, Packaging and Manufacturing Technology(Volume: 12, Issue: 2, February 2022)
- [3] IGBT Power Losses Calculation using the Data Sheet Parameters (Application Note, V 1. 1 January 2009)